

# PUSH-IN FITTINGS

Push-in fittings by Metal Work are the best elements for connecting pipes and actuators.

Quick and easy to use, the Metal Work push-in fitting can be re-used thousands of times without affecting the pneumatic and mechanical seal in any way. It comes in various configurations and guarantees a virtually unlimited, highly flexible use. The clamping spring with its special shape grips the pipe without scratching or deforming it, which facilitates release.

In the fittings, the release bushing has patented screwdriver slots to facilitate release in applications not accessible to the fingers. Configurations RL19, RL21, RL22, RL23, RL23M, RL24, RL44, and RL49 (except for Ø5), have a ring for fixing to the wall asymmetrically in order to contain the head of a screw within the overall dimensions of the fitting.

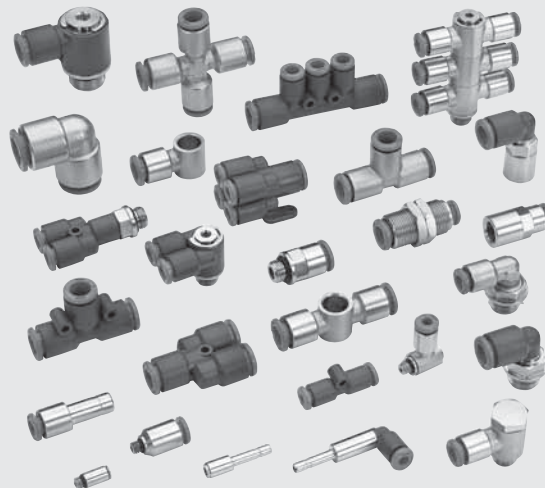

TECHNICAL DATA		
Threaded coupling		M3 - M5 - M7 - 1/8" - 1/4" - 3/8" - 1/2"
Diameter	mm	Ø 3 - Ø 3.17 - Ø 4 - Ø 5 - Ø 6 - Ø 8 - Ø 10 - Ø 12 - Ø 14
Temperature range for brass fittings	°C	- 20 to + 80
	°F	- 4 to 176
Temperature range for technopolymer fittings	°C	- 20 to + 60
	°F	- 4 to 140
Pressure range for brass fittings		- 0.99 bar ... 16 bar / - 0.099 MPa ... 1.6 MPa
Pressure range for technopolymer fittings		- 0.99 bar ... 12 bar / - 0.099 MPa ... 1.2 MPa
Recommended pipe		Rilsan PA 11 - Nylon 6 - Polyamide 12 - Polypropylene
Fluid		Vacuum - Compressed air

## COMPONENTS

- ① Ring or release bushing: technopolymer
- ② Locking bushing: brass or technopolymer
- ③ Body: brass or technopolymer
- ④ Clamping spring: stainless steel (for pipes Ø 3 and Ø 3.17 and R31 Ø 5 and R32 Ø 5: brass gripper)
- ⑤ Spring supporting ring: technopolymer
- ⑥ Seal: NBR

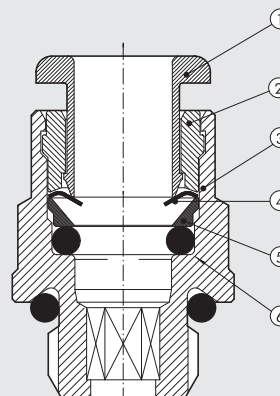

### O-RING BELOW R FITTINGS

Thread	Initials	Dimensions of O-ring
M3	.....	2.6 x 1
M5 (for Ø 3 - Ø 3.17)	.....	3 x 1.2
M5	.....	3.5 x 1.2
M7	.....	5 x 1.5
M12x1.5	.....	9.75 x 1.78
1/8	2031	7.66 x 1.78
1/4	2043	10.82 x 1.78
3/8	2056	14 x 1.78
1/2	3068	17.13 x 2.62

### FOR Ø 8 PUSH-IN FITTINGS ONLY

The new series of Ø 8 miniature push-in fittings, identified in the code by a letter L and visually by the screwdriver slot on the release ring, are not compatible with fittings R7, R8 and R9 Ø 8 in the old series.

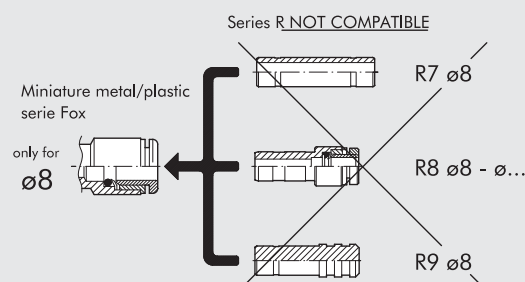

**SCREWING METHOD**

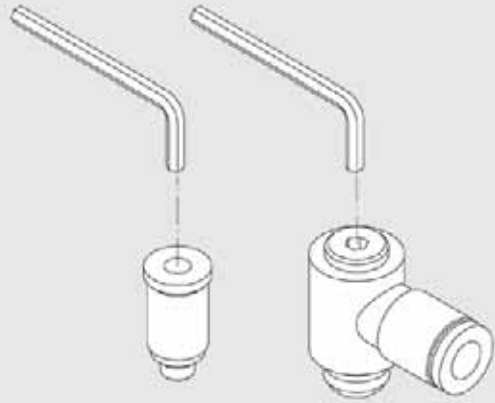
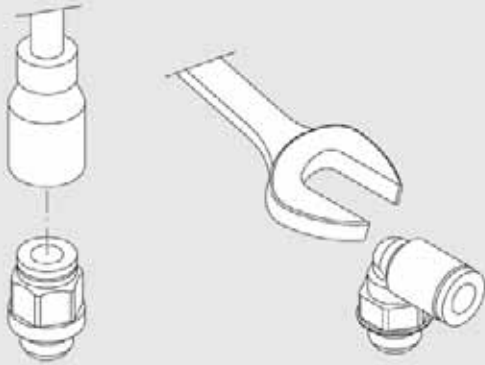

Thread	Max. Torque [Nm]
M3	0.4
M5	1.8
M7	2.5
M12x1.5	8
G 1/8"	6
G 1/4"	8
G 3/8"	10
G 1/2"	15

CH [mm]	Max. Torque [Nm]
1.5	0.4
2	0.7
2.5	1.2
3	2.5
4	5
5	8
Over 5	See the values concerning threads

**N.B.:** When using a socket spanner, the torque must not exceed that of the thread (e.g. fitting RL1 6 M7, with a 4 mm thread, has a maximum torque of 2.5 Nm, highest value of the thread)

**GENERAL FEATURES**

All fittings have cylindrical threading and incorporate a O-ring (Metal Work patent). The use of an O-ring considerably improves the seal of angled, rough, and slightly convex surfaces. Teflon® (PTFE) is no longer used.

Mounting fittings with an Allen wrench or pneumatic tool. All the elbows and tees are rotary. Drastic reduction in assembly times.

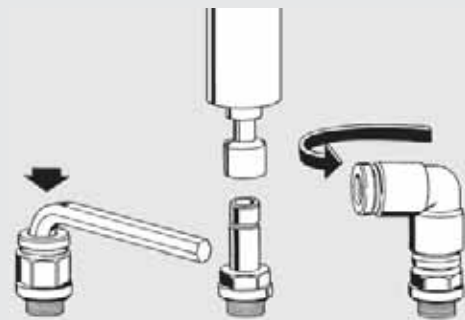
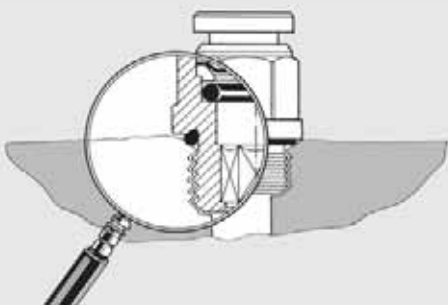

A single tee can give central tees and lateral tees.

The pipe is easy to assemble by pressing lightly on the pusher ring. To remove the fitting, merely push radially on the key.

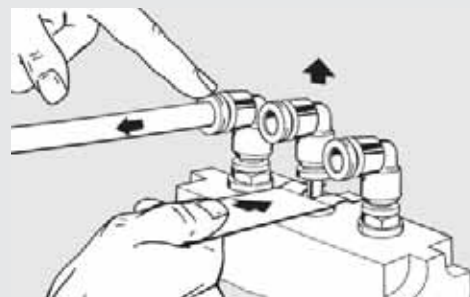
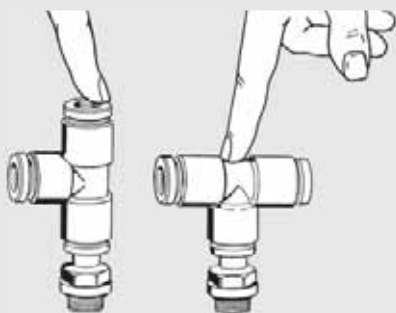

**FROM AN IDEA, A SYSTEM**

- Four basic fittings can be used to make all possible connections in a pneumatic circuit.
- Sharp drop in the number of fittings to be stocked and hence reduced operating costs.

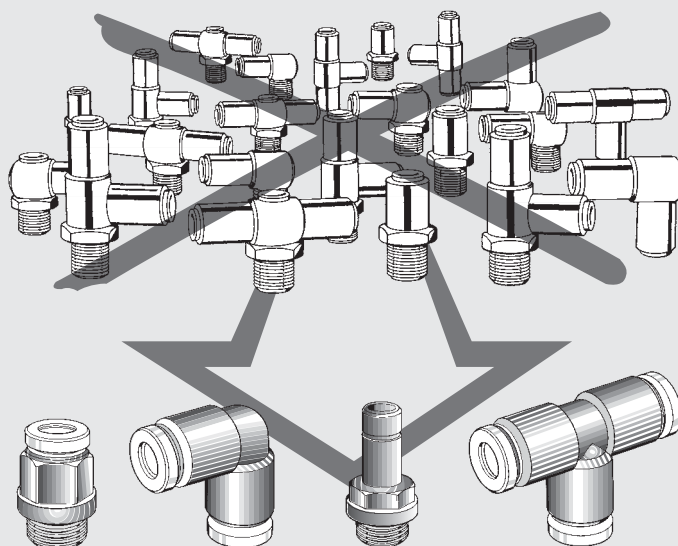

**ASSEMBLY DIAGRAM**

Pre-assembling fittings on the workbench with pneumatic tool even with very close centre distances.

Pre-assembling fittings and pipe sections on the workbench. Pre-assembled configurations can be stocked for assembly in series.

Quick connection and completion of the pneumatic circuit.

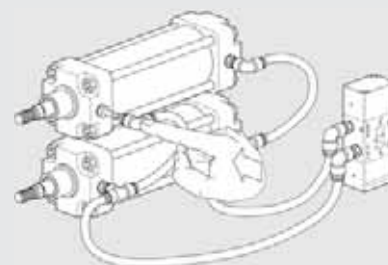
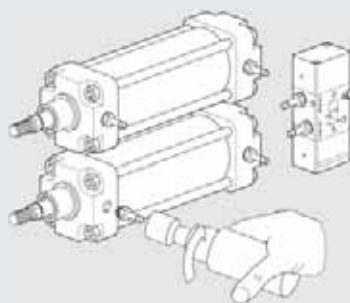

FITTINGS

PUSH-IN FITTINGS

**FROM A SYSTEM, INNOVATION**

An Allen wrench is used to assemble rotary fittings even with very close centre distances.

The special configuration with two O-rings allows maximum orientation so as to follow pipe movement in the specific application.

Fittings with a built-in gasket and reduced height (H) with the same threaded coupling and pipe diameter.

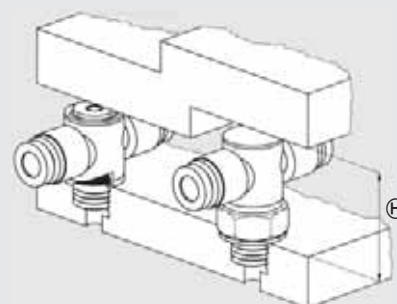
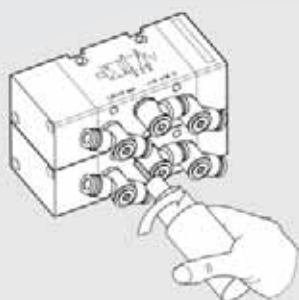

## BRASS FITTINGS

### STRAIGHT, CYLINDRICAL, MALE (R1)

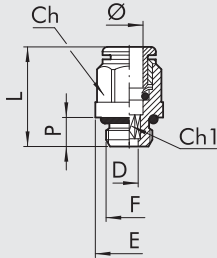

Code	Ref.	Ø	F	Ch	Ch1	P	L	D	E
2001B01	R1	3	M3	Ø 5.8	1.5	3	12.6	1.5	5.8
2001B02	R1	3	M5	Ø 5.8	2	3.5	13	2	5.8
2001A01	R1	3.17	M3	Ø 5.8	1.5	3	12.6	1.5	5.8
2001A02	R1	3.17	M5	Ø 5.8	2	3.5	13	2	5.8
2L01001	RL1	4	M5	Ø 9	2.5	4	20.3	2.6	9
2L01020	RL1	4	M7	Ø 9	3	5	18.9	3.1	9.8
2L01002	RL1	4	1/8	10	3	6	18	3.1	14
2L01003	RL1	4	1/4	10	3	8	19.8	3.1	18
2001004	R1	5	M5	Ø 12	2.5	4	22.5	2.6	12
2001005	R1	5	1/8	13	3	6	22	3.1	15
2001006	R1	5	1/4	12	3	8	24	3.1	18
2L01000	RL1	6	M5	Ø 11	2.5	4	21.9	2.6	11
2L01021	RL1	6	M7	Ø 11	4	5	23	4.1	11
2L01101	RL1	6	M12x1.5	12	4	8	23.2	4.1	17
2L01007	RL1	6	1/8	12	4	6	21.6	4.1	14
2L01008	RL1	6	1/4	12	4	8	20.3	4.1	18
2L01102	RL1	8	M12x1.5	14	6	8	24.5	6.2	17
2L01009	RL1	8	1/8	13	5	6	25.4	5.2	14
2L01010	RL1	8	1/4	14	6	8	24.4	6.2	18
2L01011	RL1	8	3/8	14	6	9	22.8	6.2	22
2L01012	RL1	10	1/4	16	7	8	29.2	7.2	18
2L01013	RL1	10	3/8	16	8	9	26.5	8.2	22
2L01018	RL1	10	1/2	16	8	11	29.8	8.2	26
2001019	RL1	12	1/4	19	7	8	30.5	7.2	21
2001014	RL1	12	3/8	19	10	9	28.1	10.2	22
2001015	RL1	12	1/2	19	10	11	29.3	10.2	26
2001016	RL1	14	3/8	22	10	9	33.8	10.2	24.6
2001017	RL1	14	1/2	22	12	11	31.5	12.2	26

### STRAIGHT, CONICAL, MALE (R1C)

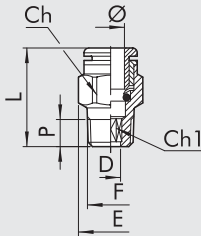

Code	Ref.	Ø	F	Ch	Ch1	D	E	L	P
2L01C02	RL1C	4	1/8	10	3	3.1	11.3	18.5	6.2
2L01C07	RL1C	6	1/8	12	4	4.1	13.5	22.5	6.2
2L01C08	RL1C	6	1/4	12	4	4.1	13.2	22.3	8.5
2001Z07	RL1Z	6	12x1 conical	12	4	4.1	13.2	23.5	9
2001Z08	RL1Z	6	12x1.25 conical	12	4	4.1	13.2	23.5	9
2L01C09	RL1C	8	1/8	13	6	6.2	14.3	26	6.2
2L01C10	RL1C	8	1/4	14	6	6.2	15.8	25.5	8.5
2L01C11	RL1C	8	3/8	14	6	6.2	16.6	24.9	9
2L01C13	RL1C	10	1/4	16	7	7.2	17.7	28.9	8.5
2L01C14	RL1C	10	3/8	16	8	8.2	17.7	26	9
2001C15	RL1C	12	3/8	19	10	10.2	21	28.5	9
2001C16	RL1C	12	1/2	19	10	10.2	21.3	26.6	11

### STRAIGHT, FEMALE (R2)

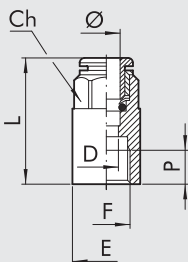

Code	Ref.	Ø	F	Ch	P	L	D	E
2002B02	R2	3	M5	7	4.5	15.7	2.5	7.8
2002A02	R2	3.17	M5	7	4.5	15.7	2.5	7.8
2L02001	RL2	4	1/8	10	7	26.2	3	14
2L02002	RL2	4	1/4	10	8	28.6	3	17
2002003	R2	5	1/8	12	7	27	4	14
2002004	R2	5	1/4	12	8	29.5	4	17
2L02005	RL2	6	1/8	12	7	27.1	5	14
2L02006	RL2	6	1/4	12	8	29.3	5	17
2L02007	RL2	8	1/8	13	7	28.1	7	14
2L02008	RL2	8	1/4	14	8	30	7	17
2L02009	RL2	10	1/4	16	8	31.8	8	17.7
2L02010	RL2	10	3/8	16	10	36.8	8	20.8
2L02011	RL2	12	3/8	19	10	37	10	20.8
2L02012	RL2	12	1/2	19	11	40.5	10	23.8

## STRAIGHT, INTERMEDIATE (R3)

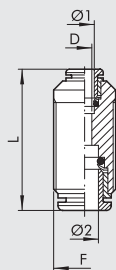

Code	Ref.	Ø 1	Ø 2	F	L	D
2003A02	R3	3	3	M8x0.75	18.4	2
2003A01	R3	3.17	3.17	M8x0.75	18.4	2
2103001	RL3	4	4	M11x1	30.6	2.5
2003002	R3	5	5	M14x1	33.5	4
2103003	RL3	6	6	M13x1	33	4.5
2103004	RL3	8	8	M15x1	35.7	6.5
2103005	RL3	10	10	M17x1	39.2	8
2003006	RL3	12	12	M20x1	40.7	10
2003007	RL3	14	14	M24x1	45.9	12
2103301	RL3	4	6	M13x1	32.7	2.5
2103302	RL3	4	8	M15x1	34.4	2.5
2103303	RL3	6	8	M15x1	35	4.5
2103304	RL3	6	10	M17x1	37.5	4.5
2103306	RL3	6	12	M20x1	39	4.5
2103305	RL3	8	10	M17x1	37.8	6.5
2103307	RL3	8	12	M20x1	40.1	6
2103308	RL3	10	12	M20x1	40.8	8

## ELBOW, INTERMEDIATE (R4)

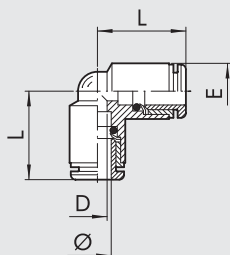

Code	Ref.	Ø	L	D	E
2004A02	R4	3	10.4	2	6.3
2004A01	R4	3.17	10.4	2	6.3
2104001	RL4	4	16.7	2.5	9.5
2004002	R4	5	19.2	3	13.5
2104003	RL4	6	19	4.5	11.5
2104004	RL4	8	21.3	6.5	13.5
2104005	RL4	10	23.3	8	16
2004006	RL4	12	26	10	20.5
2004007	RL4	14	29.3	12	22

## TEE, INTERMEDIATE (R5)

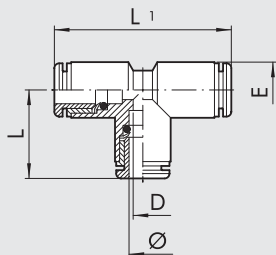

Code	Ref.	Ø	L	L1	D	E
2005A02	R5	3	10.4	20.8	2	6.3
2005A01	R5	3.17	10.4	20.8	2	6.3
2105001	RL5	4	16.7	33.4	2.5	9.5
2005002	R5	5	19.2	38.4	3	13.5
2105003	RL5	6	19	38	4.5	11.5
2105004	RL5	8	21.3	42.6	6.5	13.5
2105005	RL5	10	23.3	46.6	8	16
2005006	RL5	12	26	52	10	20.5
2005007	RL5	14	29.3	58.6	12	22

**THREADED ADAPTER (R6)**

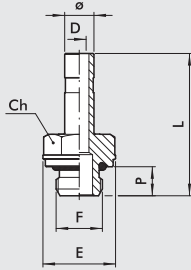

Code	Ref.	Ø	F	Ch	P	L	D	E
2006A02	R6	3	M5	5	3.5	17.1	2	5.8
2006A01	R6	3.17	M5	5	3.5	17.1	2	5.8
2006001	R6	4	M5	8	4	25.2	2.5	9
2006020	R6	4	M7	8	5	26.5	2.5	9.8
2006002	R6	4	1/8	13	6	28.9	2.5	15
2006003	R6	4	1/4	14	8	32.4	2.2	18
2006004	R6	5	M5	8	4	25.2	2.7	9
2006005	R6	5	1/8	13	6	28.9	3	15
2006006	R6	5	1/4	14	8	32.4	3	18
2006000	R6	6	M5	9	4	25.7	2.7	10
2006021	R6	6	M7	8	5	27	4	9.8
2006007	R6	6	1/8	13	6	29.4	4	15
2006008	R6	6	1/4	14	8	32.9	4	18
2006009	R6	8	1/8	13	6	30.6	5.5	15
2006010	R6	8	1/4	14	8	34	6	18
2006011	R6	8	3/8	17	9	35.4	6	22
2006012	R6	10	1/4	14	8	38.2	7.8	18
2006013	R6	10	3/8	17	9	38.7	8	22
2006022	R6	10	1/2	19	11	41	8	26
2006019	R6	12	1/4	14	8	40.7	7.8	18
2006014	R6	12	3/8	17	9	42.2	10	22
2006015	R6	12	1/2	22	11	44.2	10	26
2006016	R6	14	3/8	17	9	46.2	10	22
2006017	R6	14	1/2	22	11	48.2	12	26
2006101	R6	6	M12X1.5	13	8	33	4	17
2006102	R6	8	M12X1.5	13	8	33.7	6	17

**EXTENDED THREADED ADAPTER (R18)**

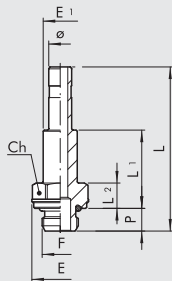

Code	Ref.	Ø	F	Ch	P	L	L1	L2	E	E1
2018002	R18	4	1/8	13	6	40.4	18.2	6.7	15	7
2018007	R18	6	1/8	13	6	43.4	20.7	6.7	15	9
2018008	R18	6	1/4	14	8	46.9	22.2	8.2	18	9
2018009	R18	8	1/8	13	6	46.5	22.7	6.7	15	11
2018010	R18	8	1/4	14	8	50	24.2	8.2	18	11
2018011	R18	8	3/8	17	9	51.4	24.7	8.7	22	13
2018012	R18	10	1/4	14	8	57.2	27.2	8.2	18	12
2018013	R18	10	3/8	17	9	58.7	27.7	8.7	22	12

**EXTENSION (R7)**

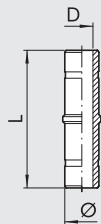

Code	Ref.	Ø	L	D
2007001	R7	4	34	2
2007002	R7	5	34	3
2007003	R7	6	37.5	4
2007004	RL7	8	37.5	6
2007005	R7	10	45	8
2007006	R7	12	48	10
2007007	R7	14	58	12

## REDUCER (R8)

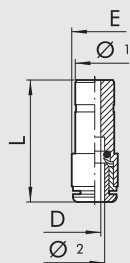

Code	Ref.	Ø 1	Ø 2	L	D	E
2008A01	R8	4	3	26	2	6.3
2008A02	R8	4	3.17	26	2	6.3
2008001	RL8	5	4	32.2	3	9.5
2108002	RL8	6	4	29.9	2.8	9.5
2008003	R8	6	5	36	4	12
2108004	RL8	8	4	28.7	2.8	9.5
2008005	R8	8	5	34.5	4	12
2108006	RL8	8	6	31.9	4.5	11.5
2108007	RL8	10	6	36.2	5	11.5
2108008	RL8	10	8	40.8	7	14
2008009	RL8	12	4	36.7	3	13
2008010	RL8	12	6	42	5	13
2008011	RL8	12	8	40.1	7	14
2008015	RL8	12	10	44.3	8.2	16
2008014	RL8	14	8	44.1	7	15.5
2008017	RL8	14	10	44.3	8.2	16
2008018	RL8	14	12	50	10	19.5

## ADDITION

2009001	RL8/M	4	6	34.5	2.5	11.5
---------	-------	---	---	------	-----	------

## PLUG (R9)

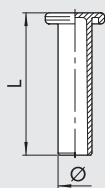

Code	Rif.	Ø	L	MATERIAL
2010A02	R9	3	20	Brass
2110A01	RL9T	3.17	19.6	Technopolymer
2110001	RL9T	4	27	Technopolymer
2010002	R9	5	27	Brass
2110003	RL9T	6	29.8	Technopolymer
2110004	RL9T	8	33.6	Technopolymer
2110005	RL9T	10	36.8	Technopolymer
2110006	RL9T	12	39	Technopolymer
2010007	R9	14	39.5	Brass

## STRAIGHT, INTERMEDIATE, BULKMTAD (R10)

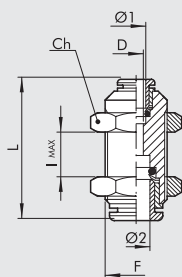

Code	Ref.	Ø 1	Ø 2	F	Ch	L	D	I max
2011A02	R10	3	3	M8x0.75	10	18.4	2	5
2011A01	R10	3.17	3.17	M8x0.75	10	18.4	2	5
2111001	RL10	4	4	M11x1	13	30.6	2.5	11
2011002	R10	5	5	M14x1	17	33.5	4	8
2111003	RL10	6	6	M13x1	16	33	4.5	12
2111004	RL10	8	8	M15x1	17	35.7	6.5	13.5
2111005	RL10	10	10	M17x1	20	39.2	8	17
2011006	RL10	12	12	M20x1	24	40.7	10	20.3
2011007	RL10	14	14	M24x1	27	45.9	12	21.9
2111301	RL10	4	6	M13x1	16	32.7	2.5	11
2111302	RL10	4	8	M15x1	17	34.4	2.5	12
2111303	RL10	6	8	M15x1	17	35	4.5	13
2111304	RL10	6	10	M17x1	20	37.5	4.5	14.5
2111306	RL10	6	12	M20x1	24	39	4.5	16
2111305	RL10	8	10	M17x1	20	37.8	6.5	15
2111307	RL10	8	12	M20x1	24	40.1	6	17.5
2111308	RL10	10	12	M20x1	24	40.8	8	19

**SINGLE RING (R13)**

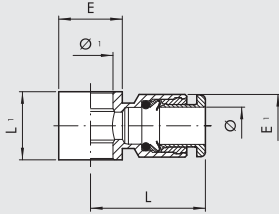

Code	Ref.	Ø	Ø 1	L	L1	E	E1
2012A02	R13	3	M5	12.9	9	9	7
2012A01	R13	3.17	M5	12.9	9	9	7
2012001	RL13	4	M5	20.2	9	9.5	9.5
2012002	RL13	4	1/8	21.3	15	14	9.5
2012003	R13	5	M5	23.8	9	9.5	12
2012004	R13	5	1/8	24.8	15	14	12
2012005	RL13	6	1/8	23	15	14	11.5
2012006	RL13	6	1/4	24.5	17	18	11.5
2012007	RL13	8	1/8	24.8	15	14	13.8
2012008	RL13	8	1/4	26.5	17	18	13.8
2012009	RL13	8	3/8	28.5	20	21	13.8
2012010	RL13	10	1/4	31.4	17	18	16.5
2012011	RL13	10	3/8	32.8	20	21	16
2012013	RL13	12	1/4	33	17	18	19.5
2012012	RL13	12	3/8	35.3	20	21	19.5
2012014	RL13	12	1/2	37	24	26	19.5

For the rods series D, see page D2.15

**DUAL RING (R14)**

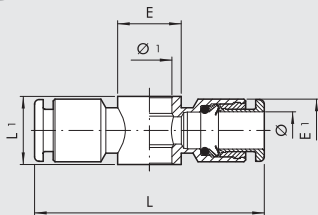

Code	Ref.	Ø	Ø 1	L	L1	E	E1
2013001	RL14	4	M5	40.4	9	9.5	9.5
2013002	RL14	4	1/8	42.6	15	14	9.5
2013003	R14	5	M5	48	9	9.5	12
2013004	R14	5	1/8	49.5	15	14	13.5
2013005	RL14	6	1/8	46	15	14	11.5
2013006	RL14	6	1/4	49	17	18	11.5
2013007	RL14	8	1/8	49.6	15	14	13.8
2013008	RL14	8	1/4	53	17	18	13.8
2013009	RL14	8	3/8	57	20	21	13.8
2013010	RL14	10	1/4	62.8	17	18	16.5
2013011	RL14	10	3/8	65.6	20	21	16

For the rods series D, see page D2.15

**ROD, MALE SINGLE ROTARY RING (R15)**

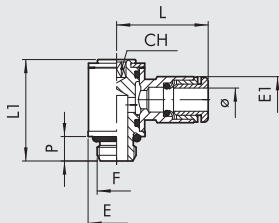

Code	Ref.	Ø	F	CH	P	L	L1	E	E1
2014101	R15	3	M3	1.5	3	12.2	13.2	5.8	5.8
2014102	R15	3.17	M3	1.5	3	12.2	13.2	5.8	5.8
2014103	R15	3	M5	2	3.5	12.7	13.7	5.8	7
2014104	R15	3.17	M5	2	3.5	12.7	13.7	5.8	7
2L14001	RL15	4	M5	2	4	20.2	18.4	9.5	9.5
2L14020	RL15	4	M7	3	5	20.2	18.5	9.8	9.5
2L14002	RL15	4	1/8	3	6	21.3	24.9	14	9.5
2014003	R15	5	M5	2	4	24	19	9.9	12
2014004	R15	5	1/8	3	6	25	27	14	12
2L14106	RL15	6	M5	2	4	23.5	18.4	9.5	11.3
2L14021	RL15	6	M7	3	5	23.5	18.5	9.8	11.3
2L14005	RL15	6	1/8	3	6	23	24.9	14	11.5
2L14007	RL15	6	1/4	4	8	24.5	29.4	18	11.5
2L14006	RL15	8	1/8	3	6	24.8	24.9	14	13.8
2L14008	RL15	8	1/4	4	8	26.5	29.4	18	13.8
2L14013	RL15	8	3/8	5	9	28.5	35.6	22	13.8
2L14009	RL15	10	1/4	4	8	31.4	29.4	18	16.5
2L14014	RL15	10	3/8	5	9	32.8	35.6	22	16
2014010	RL15	12	1/4	4	8	33	29.4	18	19.5
2014011	RL15	12	3/8	5	9	35.3	35.6	22	19.5
2014012	RL15	12	1/2	8	11	37	40.8	26	19.5



**ROD, MALE DUAL ROTARY RING (R16)**

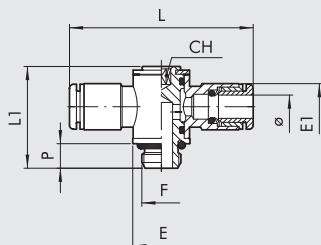

Code	Ref.	Ø	F	CH	P	L	L1	E	E1
2L15001	RL16	4	M5	2	4	40.4	18.4	9.5	9.5
2L15020	RL16	4	M7	3	5	40.4	18.5	9.8	9.5
2L15002	RL16	4	1/8	3	6	42.6	24.9	14	9.5
2015003	R16	5	M5	2	4	47.6	18.8	9.9	12
2015004	R16	5	1/8	3	6	49.5	27	14	13.5
2L15106	RL16	6	M5	2	4	47	18.4	9.5	11.3
2L15021	RL16	6	M7	3	5	47	18.5	9.8	11.3
2L15005	RL16	6	1/8	3	6	46	24.9	14	11.5
2L15007	RL16	6	1/4	4	8	49	29.4	18	11.5
2L15006	RL16	8	1/8	3	6	49.6	24.9	14	13.8
2L15008	RL16	8	1/4	4	8	53	29.4	18	13.8
2L15013	RL16	8	3/8	5	9	57	35.6	18	13.8
2L15009	RL16	10	1/4	4	8	62.8	29.4	22	16.5
2L15014	RL16	10	3/8	5	9	65.6	35.6	22	16
2015010	RL16	12	1/4	4	8	66	29.4	18	19.5
2015011	RL16	12	3/8	5	9	70.6	35.6	22	19.5
2015012	RL16	12	1/2	8	11	74	40.8	26	19.5

**ROTARY ELBOW, MALE, CYLINDRICAL (R31)**

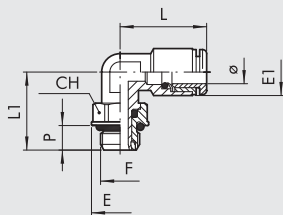

Code	Ref.	Ø	F	CH	E	E1	L	L1	P
2L31001	RL31	4	M5	9	9.9	9.5	18.6	15.3	4
2L31002	RL31	4	1/8	12	14	9.5	18.6	19.1	6
2L31003	RL31	4	1/4	14	18	9.5	18.6	21.1	8
2031004	R31	5	M5	9	9.9	13.5	22.8	17.5	4
2031005	R31	5	1/8	12	14	13.5	22.8	21	6
2031006	R31	5	1/4	14	18	13.5	22.8	24.5	8
2L31007	RL31	6	M5	9	9.9	11.8	21.9	15.3	4
2L31008	RL31	6	1/8	12	14	11.8	21.9	19.1	6
2L31009	RL31	6	1/4	14	18	11.8	21.9	21.1	8
2L31010	RL31	8	1/8	12	14	13.5	25.4	19.1	6
2L31011	RL31	8	1/4	14	18	13.5	25.4	21.1	8
2L31012	RL31	8	3/8	17	22	13.8	23.6	27.1	9
2L31013	RL31	10	1/4	14	18	16	27.2	24.8	8
2L31014	RL31	10	3/8	17	22	16	27.2	27.1	9
2031015	RL31	10	1/2	22	26	16	27.2	30.7	11
2031016	RL31	12	1/4	14	18	20	30	25.6	8
2031017	RL31	12	3/8	17	22	20	30	27.1	9
2031018	RL31	12	1/2	22	26	20	30	30.7	11
2031019	RL31	14	1/2	22	26	21.3	33	32.3	11

**ROTARY ELBOW, MALE, CONICAL (R31C)**

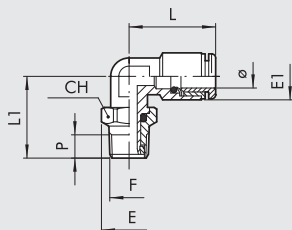

Code	Rif.	Ø	F	CH	E	E1	L	L1	P
2L31C02	RL31/C	4	1/8	12	13.3	9.5	18.6	19.8	6.2
2L31C03	RL31/C	4	1/4	14	15.4	9.5	18.6	22.6	8.5
2L31C08	RL31/C	6	1/8	12	13.3	11.8	21.9	19.8	6.2
2L31C09	RL31/C	6	1/4	14	15.4	11.8	21.9	22.6	8.5
2L31C10	RL31/C	8	1/8	12	13.3	13.5	25.4	19.8	6.2
2L31C11	RL31/C	8	1/4	14	15.4	13.5	25.4	23.6	8.5
2L31C12	RL31/C	8	3/8	17	19.2	13.8	23.6	27.1	9
2L31C13	RL31/C	10	1/4	14	15.4	16	27.2	26.3	8.5
2L31C14	RL31/C	10	3/8	17	19.2	16	27.2	27.1	9
2031C15	RL31/C	12	3/8	17	19.2	20	30	27.1	9
2031C16	RL31/C	12	1/2	22	24.6	20	30	31.9	11

**CENTRAL TEE, MALE, CYLINDRICAL, ROTARY (R32)**

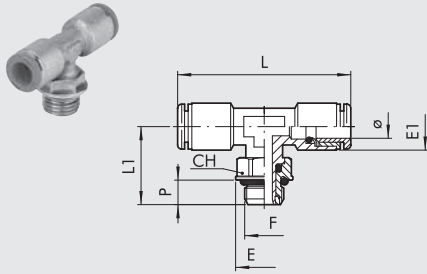

Code	Ref.	Ø	F	CH	E	EI	L	LI	P
2L32001	RL32	4	M5	9	9.9	9.5	37.2	15.3	4
2L32002	RL32	4	1/8	12	14	9.5	37.2	19.1	6
2L32003	RL32	4	1/4	14	18	9.5	37.2	21.1	8
2032005	R32	5	1/8	12	14	13.5	45.6	19.1	6
2L32004	RL32	6	M5	9	9.9	11.8	43.8	15.3	4
2L32008	RL32	6	1/8	12	14	11.8	43.8	19.1	6
2L32009	RL32	6	1/4	14	18	11.8	43.8	21.1	8
2L32010	RL32	8	1/8	12	14	13.5	50.8	19.1	6
2L32011	RL32	8	1/4	14	18	13.5	50.8	21.1	8
2L32012	RL32	8	3/8	17	22	13.8	47.2	27.1	9
2L32013	RL32	10	1/4	14	18	16	44.4	21.8	8
2L32014	RL32	10	3/8	17	22	16	44.4	27.1	9
2032017	RL32	12	3/8	17	22	20	60	27.1	9
2032018	RL32	12	1/2	22	26	20	60	30.7	11
2032019	RL32	14	1/2	22	26	21.3	66	32.3	11

**CENTRAL TEE, MALE, CONICAL, ROTARY (R32C)**

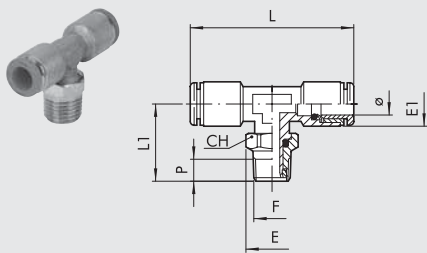

Code	Rif.	Ø	F	CH	E	EI	L	LI	P
2L32C02	RL32/C	4	1/8	12	13.3	9.5	37.2	19.8	6.2
2L32C03	RL32/C	4	1/4	14	15.4	9.5	37.2	22.6	8.5
2L32C08	RL32/C	6	1/8	12	13.3	11.8	43.8	19.8	6.2
2L32C09	RL32/C	6	1/4	14	15.4	11.8	43.8	22.6	8.5
2L32C10	RL32/C	8	1/8	12	13.3	13.5	50.8	19.8	6.2
2L32C11	RL32/C	8	1/4	14	15.4	13.5	50.8	23.6	8.5
2L32C12	RL32/C	8	3/8	17	19.2	13.8	47.2	27.1	9
2L32C13	RL32/C	10	1/4	14	15.4	16	44.4	26.3	8.5
2L32C14	RL32/C	10	3/8	17	19.2	16	44.4	27.1	9

**LATERAL TEE, MALE, CYLINDRICAL, ROTARY (R38)**

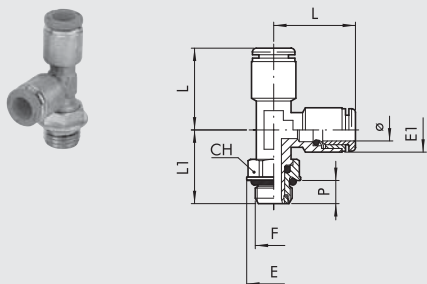

Code	Ref.	Ø	F	CH	E	EI	L	LI	P
2L38002	RL38	4	1/8	12	14	9.5	18.6	19.1	6
2038005	R38	5	1/8	12	14	13.5	22.8	19.1	6
2L38008	RL38	6	1/8	12	14	11.5	21.9	19.1	6
2L38009	RL38	6	1/4	14	18	11.5	21.9	21.1	8
2L38010	RL38	8	1/8	12	14	13.5	25.4	19.1	6
2L38011	RL38	8	1/4	14	18	13.5	25.4	22.1	8
2L38013	RL38	10	1/4	14	18	16	27.2	21.8	8
2L38014	RL38	10	3/8	17	22	16	27.2	27.1	9
2038015	RL38	12	3/8	17	22	20	30	27.1	9
2038016	RL38	12	1/2	22	26	20	30	30.7	11

**ELBOW, MALE, CONICAL (R39C)**

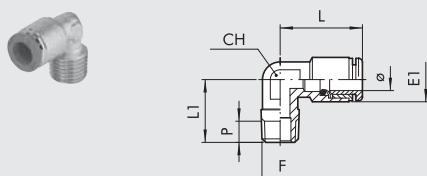

Code	Rif.	Ø	F	CH	EI	L	LI	P	
2L39C02	RL39/C	4	1/8		10	9.5	18.6	16	6.2
2L39C08	RL39/C	6	1/8		10	11.8	21.9	16	6.2
2L39C09	RL39/C	6	1/4		10	11.8	21.9	18.5	8.5
2039Z07	RL39/Z	6	12x1 conical		10	11.8	21.9	17.5	7
2039Z08	RL39/Z	6	12x1.25 conical		10	11.8	21.9	17.5	7
2L39C10	RL39/C	8	1/8		10	13.5	25.4	16	6.2
2L39C11	RL39/C	8	1/4		10	13.5	25.4	18.5	8.5
2L39C13	RL39/C	10	1/4		14	16	27.2	22	8.5

CROSS FITTING (R40)

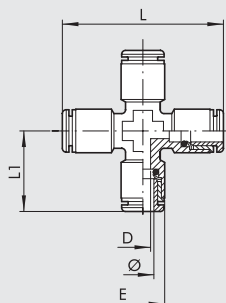

Code	Ref.	Ø	D	E	L	L1
2L40001	RL40	4	3	9.5	37.2	18.6
2L40003	RL40	6	4.5	11.3	43.8	21.9
2L40004	RL40	8	6.5	14	50.8	25.4

DUAL ROD SINGLE ROTARY RINGS (R50)

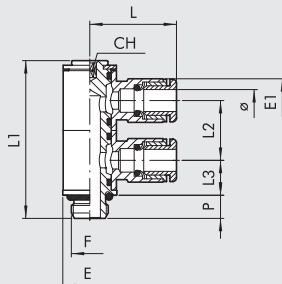

Code	Ref.	Ø	F	CH	E	E1	L	L1	L2	L3	P
2L50001	RL50	4	M5	2	9.5	9.5	20.2	30.3	11.5	6.8	4
2L50002	RL50	4	1/8	3	14	9.5	20.2	40.9	15.5	9.1	6
2033002	R33	5	1/8	5	14	12	25	42	15	10.5	6
2L50007	RL50	6	M5	2	9.5	11.3	23.5	30.3	11.5	6.8	4
2L50008	RL50	6	1/8	3	14	11.3	23.5	40.9	15.5	9.1	6
2L50009	RL50	6	1/4	4	18	11.5	23	47	17.2	10.2	8
2L50010	RL50	8	1/8	3	14	13.8	24.8	40.9	15.5	9.1	6
2L50011	RL50	8	1/4	4	18	13.8	26.5	47	17.2	10.2	8
2L50013	RL50	10	1/4	4	18	16.5	31.4	47	17.2	10.2	8

DUAL ROD DUAL ROTARY RINGS (R51)

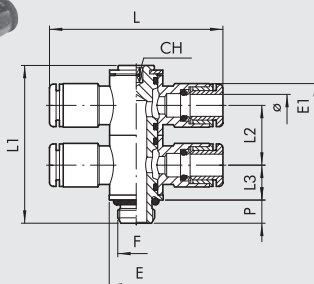

Code	Ref.	Ø	F	CH	E	E1	L	L1	L2	L3	P
2L51001	RL51	4	M5	2	9.5	9.5	40.4	30.3	11.5	6.8	4
2L51002	RL51	4	1/8	3	14	9.5	40.4	40.9	15.5	9.1	6
2L51007	RL51	6	M5	2	9.5	11.3	47	30.3	11.5	6.8	4
2L51008	RL51	6	1/8	3	14	11.3	47	40.9	15.5	9.1	6
2L51009	RL51	6	1/4	4	18	11.5	46	47	17.2	10.2	8
2L51010	RL51	8	1/8	3	14	13.8	49.6	40.9	15.5	9.1	6
2L51011	RL51	8	1/4	4	18	13.8	53	47	17.2	10.2	8
2L51013	RL51	10	1/4	4	18	16.5	62.8	47	17.2	10.2	8

TRIPLE ROD SINGLE ROTARY RINGS (R52)

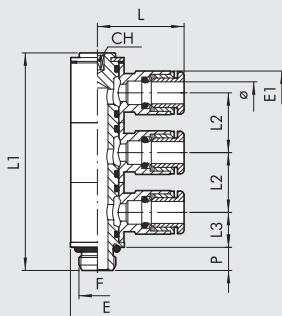

Code	Ref.	Ø	F	CH	E	E1	L	L1	L2	L3	P
2L52002	RL52	4	1/8	3	14	9.5	20.2	56.7	15.5	9.1	6
2L52008	RL52	6	1/8	3	14	11.3	23.5	56.7	15.5	9.1	6
2L52009	RL52	6	1/4	4	18	11.5	23	64.3	17.2	10.2	8
2L52010	RL52	8	1/8	3	14	13.8	24.8	56.7	15.5	9.1	6
2L52011	RL52	8	1/4	4	18	13.8	26.5	64.3	17.2	10.2	8
2L52013	RL52	10	1/4	4	18	16.5	31.4	64.3	17.2	10.2	8

**TRIPLE ROD DUAL ROTARY RINGS (R53)**

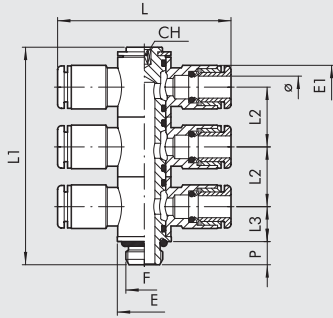

Code	Ref.	Ø	F	CH	E	EI	L	L1	L2	L3	P
2L53002	RL53	4	1/8	3	14	9.5	40.2	56.7	15.5	9.1	6
2L53008	RL53	6	1/8	3	14	11.3	47	56.7	15.5	9.1	6
2L53009	RL53	6	1/4	4	18	11.5	46	64.3	17.2	10.2	8
2L53010	RL53	8	1/8	3	14	13.8	49.6	56.7	15.5	9.1	6
2L53011	RL53	8	1/4	4	18	13.8	53	64.3	17.2	10.2	8
2L53013	RL53	10	1/4	4	18	16.5	62.8	64.3	17.2	10.2	8

**MALE ROD, SINGLE SWIVEL RING (R54)**

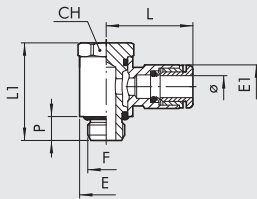

Code	Ref.	Ø	F	CH	E	EI	L	L1	P
2L54001	RL54	4	M5	9	9.5	9.5	20.2	18.7	4.5
2L54002	RL54	4	1/8	13	14	9.5	21.3	25.3	6.2
2L54007	RL54	6	M5	9	9.5	11.3	23.5	18.7	4.5
2L54008	RL54	6	1/8	13	14	11.5	23	25.3	6.2
2L54009	RL54	6	1/4	16	18	11.5	24.5	29.2	8
2L54010	RL54	8	1/8	13	14	13.8	24.8	25.3	6.2
2L54011	RL54	8	1/4	16	18	13.8	26.5	29.2	8
2L54012	RL54	8	3/8	20	21	13.8	28.5	35.4	9
2L54013	RL54	10	1/4	16	18	16.5	31.4	29.2	8
2L54014	RL54	10	3/8	20	21	16	32.8	35.4	9
2L54018	RL54	12	1/4	16	18	19.5	33	29.2	8
2L54016	RL54	12	3/8	20	21	19.5	35.3	35.4	9
2L54017	RL54	12	1/2	25	26	19.5	37	40	11

**MALE ROD, DUAL SWIVEL RING (R55)**

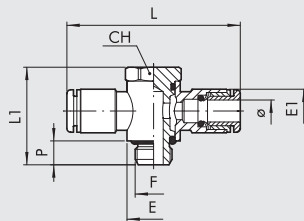

Code	Ref.	Ø	F	CH	E	EI	L	L1	P
2L55001	RL55	4	M5	9	9.5	9.5	40.4	18.7	4.5
2L55002	RL55	4	1/8	13	14	9.5	42.6	25.3	6
2L55007	RL55	6	M5	9	9.5	11.3	47	18.7	4.5
2L55008	RL55	6	1/8	13	14	11.5	46	25.3	6
2L55009	RL55	6	1/4	16	18	11.5	49	29.2	8
2L55010	RL55	8	1/8	13	14	13.8	49.6	25.3	6
2L55011	RL55	8	1/4	16	18	13.8	53	29.2	8
2L55012	RL55	8	3/8	20	21	13.8	57	35.4	9
2L55013	RL55	10	1/4	16	18	16.5	62.8	29.2	8
2L55014	RL55	10	3/8	20	21	16	65.6	35.4	9
2L55018	RL55	12	1/4	16	18	19.5	66	29.2	8
2L55016	RL55	12	3/8	20	21	19.5	70.6	35.4	9
2L55017	RL55	12	1/2	25	26	19.5	74	40	11

## DUAL ROD, MALE SINGLE SWIVEL RINGS (R56)

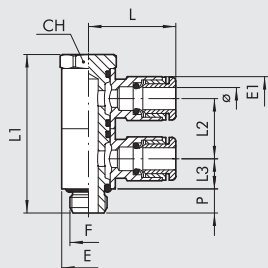

Code	Ref.	Ø	F	CH	E	E1	L	L1	L2	L3	P
2L56001	RL56	4	M5	9	9.5	9.5	20.2	30.2	11.5	5.8	4.5
2L56002	RL56	4	1/8	13	14	9.5	21.3	41	15.5	7.8	6
2L56007	RL56	6	M5	9	9.5	11.3	23.5	30.2	11.5	5.8	4.5
2L56008	RL56	6	1/8	13	14	11.5	23	41	15.5	7.8	6
2L56009	RL56	6	1/4	16	18	11.5	24.5	46.4	17.2	8.6	8
2L56010	RL56	8	1/8	13	14	13.8	24.8	41	15.5	7.8	6
2L56011	RL56	8	1/4	16	18	13.8	26.5	46.4	17.2	8.6	8
2L56012	RL56	8	3/8	20	21	13.8	28.5	56.8	21.4	10.7	9
2L56013	RL56	10	1/4	16	18	16.5	31.4	46.4	17.2	8.6	8
2L56014	RL56	10	3/8	20	21	16	32.8	56.8	21.4	10.7	9
2L56016	RL56	12	3/8	20	21	19.5	35.3	56.8	21.4	10.7	9
2L56017	RL56	12	1/2	25	26	19.5	37	64	24	12	11

## DUAL ROD, MALE DUAL SWIVEL RINGS (R57)

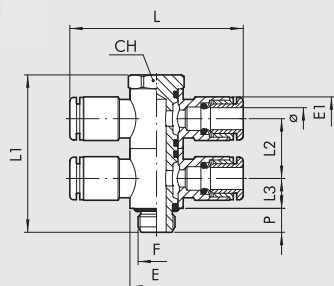

Code	Ref.	Ø	F	CH	E	E1	L	L1	L2	L3	P
2L57001	RL57	4	M5	9	9.5	9.5	40.4	30.2	11.5	5.8	4.5
2L57002	RL57	4	1/8	13	14	9.5	42.6	41	15.5	7.8	6
2L57007	RL57	6	M5	9	9.5	11.3	47	30.2	11.5	5.8	4.5
2L57008	RL57	6	1/8	13	14	11.5	46	41	15.5	7.8	6
2L57009	RL57	6	1/4	16	18	11.5	49	46.4	17.2	8.6	8
2L57010	RL57	8	1/8	13	14	13.8	49.6	41	15.5	7.8	6
2L57011	RL57	8	1/4	16	18	13.8	53	46.4	17.2	8.6	8
2L57012	RL57	8	3/8	20	21	13.8	57	56.8	21.4	10.7	9
2L57013	RL57	10	1/4	16	18	16.5	62.8	46.4	17.2	8.6	8
2L57014	RL57	10	3/8	20	21	16	65.6	56.8	21.4	10.7	9
2L57016	RL57	12	3/8	20	21	19.5	70.6	56.8	21.4	10.7	9
2L57017	RL57	12	1/2	25	26	19.5	74	64	24	12	11

## TAPERED THREAD BRASS FITTINGS WITH PTFE

Metal Work can supply fittings with a tapered thread coated in polytetrafluorethylene. This system provides the pneumatic seal between the fitting and the female thread. It is therefore not necessary to add other sealing systems during assembly, such as adhesives or Teflon tape. This significantly reduces assembly times. The physical and technical features of the material used ensure that the properties are maintained through time and in a wide range of operating temperatures. This coating can be used with push-in fittings type R1C, R31C, R32C and R39C that have a 1/8" to 1/2" gas taper thread.

## KEY TO CODES

Fittings with a PTFE thread have the same code as the standard fitting, with the addition of the suffix T. For example RL1C 8 3/8 fitting has code **2L01C11**, so the PTFE version has code **2L01C11T**.

## TECHNOPOLYMER FITTINGS

### STRAIGHT, INTERMEDIATE, TECHNOPOLYMER (R19)

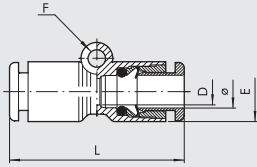

Code	Ref.	Ø	E	L	D	F
2019001	RL19	4	9.2	30.4	3	3.3
2019002	R19	5	14	33.5	4	-
2019003	RL19	6	11.3	33	5	3.3
2019004	RL19	8	13.8	36.2	6.5	3.3
2019005	RL19	10	16	38	8.5	3.3
2019006	RL19	12	19.5	40	10.5	3.3

### MALE ROD, SINGLE ROTARY RING, TECHNOPOLYMER (R20)

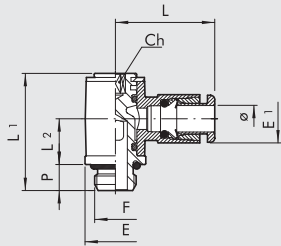

Code	Ref.	Ø	F	Ch	P	L	L1	L2	E	E1
2020001	RL20	4	M5	2	4	18.7	18.4	9.1	8	9.2
2020002	RL20	4	1/8	3	6	21	24.9	12.3	14	9.2
2020003	R20	5	M5	2	4	21.5	18.8	8.5	9.9	13.5
2020004	R20	5	1/8	3	6	23	27	10.5	14	13.5
2020016	RL20	6	M5	2	4	20.8	18.4	9.1	8	11.3
2020005	RL20	6	1/8	3	6	22.3	24.9	12.3	14	11.3
2020007	RL20	6	1/4	4	8	24.3	29.4	14.3	18	11.3
2020006	RL20	8	1/8	3	6	25.6	24.9	12.3	14	13.8
2020008	RL20	8	1/4	4	8	27.2	29.4	14.3	18	13.8
2020009	RL20	10	1/4	4	8	28.6	29.4	14.3	18	16
2L20017	RL20	10	3/8	5	9	30.5	35.6	15.3	22	16
2020010	RL20	12	1/4	4	8	31	29.4	14.3	18	19.5
2020011	RL20	12	3/8	5	9	32.4	35.6	17.5	22	19.5
2020012	RL20	12	1/2	8	11	34	40.8	19.2	26	19.5

### MALE ROD, DUAL ROTARY RING, TECHNOPOLYMER (R20/A)

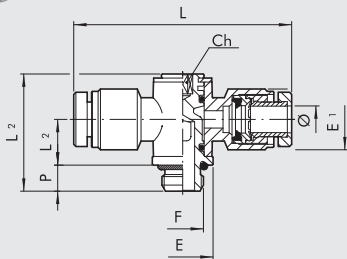

Code	Ref.	Ø	F	Ch	P	L	L1	L2	E	E1
2020A01	R20/A	4	M5	2	4	40	16.8	6.5	9.9	10.9
2020A02	R20/A	4	1/8	3	6	45	27	10.5	14	12.5
2020A03	R20/A	5	M5	2	4	43	18.8	8.5	9.9	13.5
2020A04	R20/A	5	1/8	3	6	46	27	10.5	14	13.5
2020A05	R20/A	6	1/8	3	6	45	27	10.5	14	15
2020A07	R20/A	6	1/4	4	8	48	31.5	11.5	18	15
2020A06	R20/A	8	1/8	3	6	51	27	10.5	14	16.3
2020A08	R20/A	8	1/4	4	8	54	31.5	11.5	18	16.3
2020A09	R20/A	10	1/4	4	8	64	31.5	11.5	18	18.5
2020A10	R20/A	12	1/4	4	8	64	31.5	11.5	18	21
2020A11	R20/A	12	3/8	5	9	68	36	13.5	22	21
2020A12	R20/A	12	1/2	8	11	72	42	16.2	26	21

### ELBOW, INTERMEDIATE, TECHNOPOLYMER (R21)

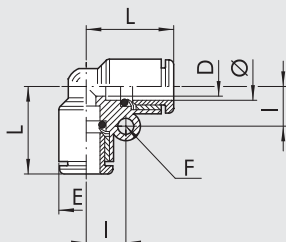

Code	Ref.	Ø	L	D	E	I	F
2L21001	RL21	4	16.7	2.5	9.2	7.2	3.3
2021002	R21	5	20	3.5	13.5	-	-
2L21003	RL21	6	19	4.2	11.3	8.2	3.3
2L21004	RL21	8	21.4	6.2	13.8	9.6	3.3
2021005	RL21	10	24	8.5	16	10.9	3.3
2021006	RL21	12	25.8	10.5	19.5	12.5	3.3

**INTERMEDIATE TEE, TECHNOPOLYMER (R22)**

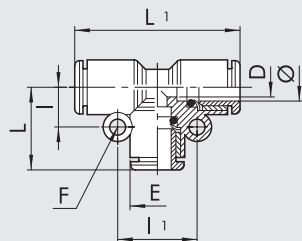

Code	Ref.	Ø	L	L1	D	E	I	I1	F
2L22001	RL22	4	16.7	33.4	2.5	9.2	7.2	14.4	3.3
2022002	R22	5	20	40	3.5	13.5	-	-	-
2L22003	RL22	6	19	38	4.2	11.3	8.2	16.4	3.3
2L22004	RL22	8	21.4	42.8	6.2	13.8	9.6	19.2	3.3
2022005	RL22	10	24	48	8.5	16	10.9	21.8	3.3
2022006	RL22	12	25.8	51.6	10.5	19.5	12.5	25	3.3

**WYE (R23)**

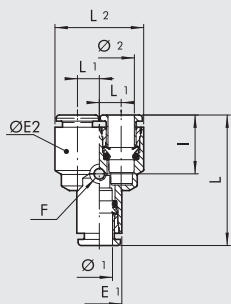

Code	Ref.	Ø1	Ø2	L	L1	E1	ØE2	I	F	L2
2023001	RL23	4	4	32.9	5	9.2	9.2	14.8	3.3	19.2
2023002	R23	5	5	35.5	6.5	13.5	13.5	-	-	26.5
2023003	RL23	6	6	35.5	5.8	11.3	11.3	15	3.3	22.8
2023004	RL23	8	8	39.5	7.2	13.8	13.8	15.8	3.3	28.2
2L23005	RL23	10	10	43.1	8.3	16	16	17.4	3.3	32.6
2L23006	RL23	12	12	48	10	19.5	19.5	18	3.3	39.5
2L23301	RL23	6	4	34.2	5	11.3	9.2	14.8	3.3	19.2
2L23303	RL23	8	6	37.8	5.8	13.8	11.3	15	3.3	22.8
2L23306	RL23	10	8	40.4	7.2	16	13.8	15.8	3.3	28.2
2L23309	RL23	12	10	44.2	8.3	19.5	16	17.4	3.3	32.6

**Y TECHNOPOLYMER, THREADED INPUT (R23/M)**

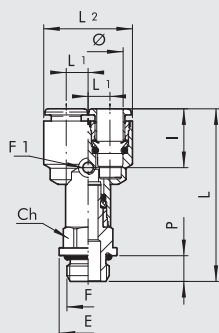

Code	Ref.	Ø	F	L	L1	L2	I	Ch	P	E	F1
2L23401	RL23/M	4	M5	38.7	5	19.2	14.8	9	4	9.9	3.3
2L23402	RL23/M	4	1/8	42.6	5	19.2	14.8	12	6	14	3.3
2L23403	RL23/M	4	1/4	46.6	5	19.2	14.8	14	8	18	3.3
2L23406	RL23/M	6	1/8	44.9	5.75	22.8	15	12	6	14	3.3
2L23407	RL23/M	6	1/4	47.9	5.75	22.8	15	14	8	18	3.3
2L23409	RL23/M	8	1/8	48.4	7.2	28.2	15.8	14	6	15	3.3
2L23410	RL23/M	8	1/4	52.8	7.2	28.2	15.8	14	8	18	3.3
2L23412	RL23/M	8	3/8	54.4	7.2	28.2	15.8	17	9	22	3.3
2L23413	RL23/M	10	1/4	53.8	8.3	32.6	17.4	16	8	18	3.3
2L23415	RL23/M	10	3/8	56	8.3	32.6	17.4	17	9	20	3.3
2L23419	RL23/M	12	3/8	62	10	39.5	18	19	9	22	3.3
2L23420	RL23/M	12	1/2	62.3	10	39.5	18	22	11	26	3.3

**Y BRANCH WITH ADAPTER, TECHNOPOLYMER (R24)**

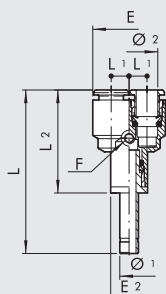

Code	Ref.	Ø1	Ø2	L	L1	L2	E1	E2	I	F
2024001	RL24	4	4	46.9	5	29.7	9.2	9.2	14.8	3.3
2024003	RL24	6	6	49.7	5.75	32	11.3	11.3	15	3.3
2L24004	RL24	8	8	55.1	7.2	35.9	13.8	13.8	15.8	3.3
2L24005	RL24	10	10	63.1	8.3	39.2	16	16	17.4	3.3
2L24006	RL24	12	12	70.5	10	44	19.5	19.5	18	3.3
2L24301	RL24	6	4	48.4	5	30.7	9.2	11.3	14.8	3.3
2L24303	RL24	8	6	53.4	5.75	34.2	11.3	13.8	15	3.3
2L24306	RL24	10	8	60.4	7.2	36.6	13.8	16	15.8	3.3
2L24309	RL24	12	10	66.7	8.3	40.2	16	19.5	17.4	3.3

**TECHNOPOLYMER PARALLEL Y, THREADED INPUT (R25)**

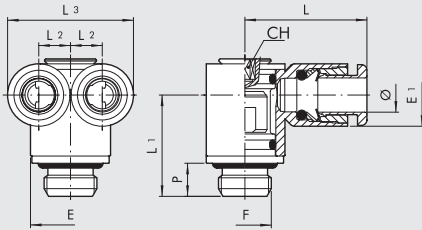

Code	Ref.	Ø	F	L	L1	L2	L3	E	E1	CH	P
2L25001	RL25	4	M5	17.7	13.1	5	19.2	8	9.2	2	4
2L25002	RL25	4	M7	17.7	14.6	5	19.2	9.8	9.2	3	5
2L25003	RL25	4	1/8	17.7	16.5	5	19.2	13	9.2	3	6
2L25004	RL25	6	1/8	23	18.3	5.75	22.8	14	11.3	3	6
2L25005	RL25	6	1/4	23	21.2	5.75	22.8	16.4	11.3	4	8
2L25008	RL25	8	1/4	25.8	22.2	7.2	28.2	18	13.8	4	8
2L25009	RL25	8	3/8	25.8	23.8	7.2	28.2	20	13.8	5	9

**SINGLE RING, TECHNOPOLYMER (R28)**

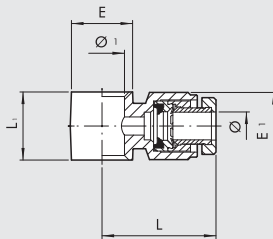

Code	Ref.	Ø	Ø 1	L	L1	E	E1
2012102	R28	4	1/8	22.5	17	15	12.5
2012104	R28	5	1/8	23	17	15	13.5
2012106	R28	6	1/8	22.5	17	15	15
2012107	R28	6	1/4	24	19	18	15
2012108	R28	8	1/8	25.5	17	15	16.5
2012109	R28	8	1/4	27	19	18	16.5
2012110	R28	8	3/8	29	22	21.5	16.5
2012111	R28	10	1/4	32	19	18	18.5
2012112	R28	10	3/8	32	22	21.5	18.5
2012113	R28	12	1/4	32	19	18	21
2012114	R28	12	3/8	34	22	21.5	21
2012115	R28	12	1/2	36	24	26	21

For the rods series D, see page D2.15

**DUAL RING, TECHNOPOLYMER (R29)**

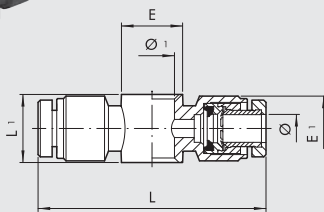

Code	Ref.	Ø	Ø 1	L	L1	E	E1
2013102	R29	4	1/8	45	17	15	12.5
2013104	R29	5	1/8	46	17	15	13.5
2013106	R29	6	1/8	45	17	15	15
2013107	R29	6	1/4	48	19	18	15
2013108	R29	8	1/8	51	17	15	16.5
2013109	R29	8	1/4	54	19	18	16.5
2013110	R29	8	3/8	58	22	21.5	16.5
2013111	R29	10	1/4	64	19	18	18.5
2013112	R29	10	3/8	64	22	21.5	18.5
2013113	R29	12	1/4	64	19	18	21
2013114	R29	12	3/8	68	22	21.5	21
2013115	R29	12	1/2	72	24	26	21

For the rods series D, see page D2.15

**ROTARY ELBOW, MALE, TECHNOPOLYMER (R34)**

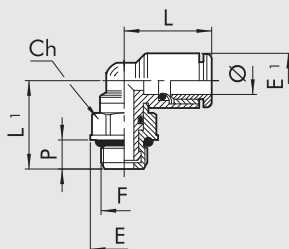

Code	Ref.	Ø	F	Ch	P	L	L1	E	E1
2L34001	RL34	4	M5	8	4	16.4	15.2	9	9.2
2L34020	RL34	4	M7	8	5	16.4	16.2	9.8	9.2
2L34002	RL34	4	1/8	12	6	16.4	17.2	14	9.2
2L34003	RL34	4	1/4	14	8	16.4	20.1	18	9.2
2L34006	RL34	6	M5	8	4	18	16.3	9	11.3
2L34021	RL34	6	M7	9	5	19	17.5	9.9	11.3
2L34007	RL34	6	1/8	12	6	19	18.3	14	11.3
2L34008	RL34	6	1/4	14	8	19	21.2	18	11.3
2L34009	RL34	8	1/8	12	6	20.2	19.5	14	13.8
2L34010	RL34	8	1/4	14	8	20.2	22.4	18	13.8
2L34011	RL34	8	3/8	17	9	20.2	24.4	22	13.8
2L34013	RL34	10	1/4	14	8	23.3	23.5	18	16
2L34014	RL34	10	3/8	17	9	23.3	25.6	22	16
2L34016	RL34	12	3/8	17	9	25.2	27.3	22	19.5
2L34017	RL34	12	1/2	19	11	25.2	30.3	26	19.5



## ELBOW, FEMALE, ROTARY, TECHNOPOLYMER (R34/F)

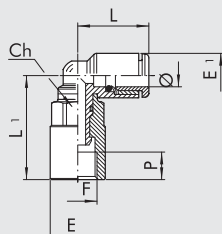

Code	Ref.	Ø	F	Ch	E	E1	L	L1	P
2L34F01	RL34/F	4	M5	8	9	9.2	16.4	15.3	4
2L34F05	RL34/F	4	1/8	12	14	9.2	16.4	20.9	7
2L34F06	RL34/F	6	M5	8	9	11.3	18	16.4	4
2L34F07	RL34/F	6	1/8	12	14	11.3	19	26.5	7
2L34F08	RL34/F	6	1/4	14	17	11.3	19	28.2	8
2L34F09	RL34/F	8	1/8	12	14	13.8	20.2	27.7	7
2L34F10	RL34/F	8	1/4	14	17	13.8	20.2	29.4	8
2L34F13	RL34/F	10	1/4	14	17	16	23.3	33	8
2L34F14	RL34/F	10	3/8	17	21	16	23.3	38	10
2L34F16	RL34/F	12	3/8	17	21	19.5	25.2	40.3	10
2L34F17	RL34/F	12	1/2	19	23.8	19.5	25.2	42.8	11

## CENTRAL TEE, MALE, TECHNOPOLYMER (R35)

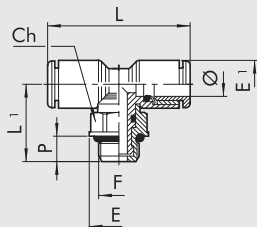

Code	Ref.	Ø	F	Ch	P	L	L1	E	E1
2L35001	RL35	4	M5	8	4	32.8	15.2	9	9.2
2L35020	RL35	4	M7	8	5	32.8	16.2	9.8	9.2
2L35002	RL35	4	1/8	12	6	32.8	17.2	14	9.2
2L35003	RL35	4	1/4	14	8	32.8	20.1	18	9.2
2L35006	RL35	6	M5	8	4	36	16.3	9	11.3
2L35007	RL35	6	1/8	12	6	38	18.3	14	11.3
2L35008	RL35	6	1/4	14	8	38	21.2	18	11.3
2L35009	RL35	8	1/8	12	6	40.4	19.5	14	13.8
2L35010	RL35	8	1/4	14	8	40.4	22.4	18	13.8
2L35011	RL35	8	3/8	17	9	40.4	24.4	22	13.8
2L35013	RL35	10	1/4	14	8	46.6	23.5	18	16
2L35014	RL35	10	3/8	17	9	46.6	25.6	22	16
2L35016	RL35	12	3/8	17	9	50.4	27.3	22	19.5
2L35017	RL35	12	1/2	19	11	50.4	30.3	26	19.5

## CENTRAL TEE, FEMALE, ROTARY, TECHNOPOLYMER (R35/F)

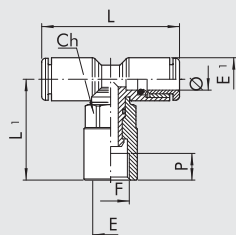

Code	Ref.	Ø	F	Ch	E	E1	L	L1	P
2L35F01	RL35/F	4	M5	8	9	9.2	32.8	15.3	4
2L35F06	RL35/F	6	M5	8	9	11.3	36	16.4	4
2L35F07	RL35/F	6	1/8	12	14	11.3	38	26.5	7
2L35F08	RL35/F	6	1/4	14	17	11.3	38	28.2	8
2L35F09	RL35/F	8	1/8	12	14	13.8	40.4	27.7	7
2L35F10	RL35/F	8	1/4	14	17	13.8	40.4	29.4	8
2L35F13	RL35/F	10	1/4	14	17	16	46.6	33	8
2L35F14	RL35/F	10	3/8	17	21	16	46.6	38	10
2L35F16	RL35/F	12	3/8	17	21	19.5	50.4	40.3	10
2L35F17	RL35/F	12	1/2	19	23.8	19.5	50.4	42.8	11

## ROTARY ELBOW, MALE, EXTENDED, TECHNOPOLYMER (R36)

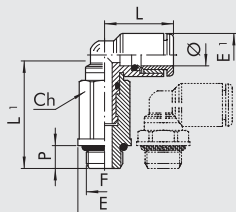

Code	Ref.	Ø	F	Ch	P	L	L1	E	E1
2L36001	RL36	4	M5	8	4	16.4	26.7	9	9.2
2L36020	RL36	4	M7	8	5	16.4	27.7	9.8	9.2
2L36002	RL36	4	1/8	12	6	16.4	25.3	14	9.2
2L36006	RL36	6	M5	8	4	18	27.8	9	11.3
2L36021	RL36	6	M7	9	5	18	29.3	9.9	11.3
2L36007	RL36	6	1/8	12	6	19	30.9	14	11.3
2L36008	RL36	6	1/4	14	8	19	33.2	18	11.3
2L36009	RL36	8	1/8	12	6	20.2	32.1	14	13.8
2L36010	RL36	8	1/4	14	8	20.2	34.4	18	13.8
2L36012	RL36	10	1/4	14	8	23.3	38	18	16

**CENTRAL TEE, MALE, ROTARY, EXTENDED, TECHNOPOLYMER (R37)**

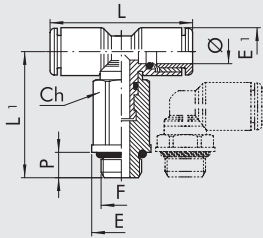

Code	Ref.	Ø	F	Ch	P	L	L1	E	E1
2L37001	RL37	4	M5	8	4	32.8	26.7	9	9.2
2L37020	RL37	4	M7	8	5	32.8	27.5	9.8	9.2
2L37002	RL37	4	1/8	12	6	32.8	25.3	14	9.2
2L37006	RL37	6	M5	8	4	36	27.8	9	11.3
2L37007	RL37	6	1/8	12	6	38	30.9	14	11.3
2L37008	RL37	6	1/4	14	8	38	33.2	18	11.3
2L37009	RL37	8	1/8	12	6	40.4	32.1	14	13.8
2L37010	RL37	8	1/4	14	8	40.4	34.4	18	13.8
2L37012	RL37	10	1/4	14	8	46.6	38	18	16

**DUAL Y BRANCH TECHNOPOLYMER (R42)**

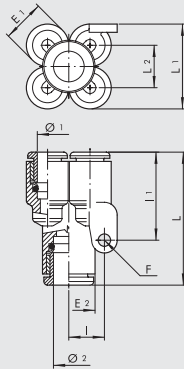

Code	Ref.	Ø1	Ø2	E1	E2	L	L1	L2	I	I1	F
2L42001	RL42	4	4	9.2	9.2	28.8	17.9	8.7	8	21.3	3.3
2L42002	RL42	4	6	9.2	11.3	31.3	17.9	8.7	8	21.3	3.3
2L42004	RL42	6	6	11.3	11.3	33.4	22.6	11.3	9.5	25.6	3.3
2L42005	RL42	6	8	11.3	14	34.8	22.6	11.3	9.5	25.6	3.3

**DUAL Y BRANCH TECHNOPOLYMER, THREADED INPUT (R43)**

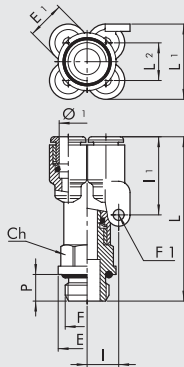

Code	Ref.	Ø1	F	E1	E	Ch	P	L	L1	L2	I	I1	F1
2L43001	RL43	4	M5	9.2	8	9	4	35.5	17.9	8.7	8	21.3	3.3
2L43002	RL43	4	1/8	9.2	14	12	6	41.6	17.9	8.7	8	21.3	3.3
2L43003	RL43	4	1/4	9.2	18	14	8	44.6	17.9	8.7	8	21.3	3.3
2L43008	RL43	6	1/8	11.3	14	12	6	43.7	22.6	11.3	9.5	25.6	3.3
2L43009	RL43	6	1/4	11.3	18	14	8	46.7	22.6	11.3	9.5	25.6	3.3

**MULTIPLE MANIFOLD, TECHNOPOLYMER (R44)**

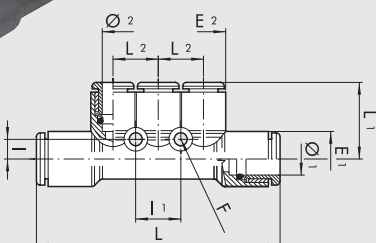

Code	Ref.	Ø1	Ø2	E1	E2	L	L1	L2	I	I1	F
2L44001	RL44	6	4	11.3	9.2	53.2	17.2	9.4	4.3	9.4	3.3
2L44003	RL44	8	6	14	11.3	61.4	19.6	11.5	5	11.5	3.3

**MULTIPLE MANIFOLD, INPUT, THREADED, TECHNOPOLYMER (R45)**

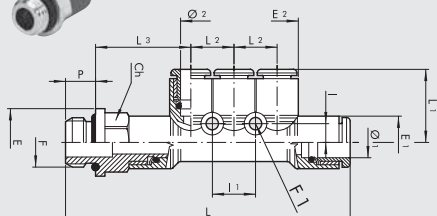

Code	Ref.	F	Ø1	Ø2	E1	E2	E	Ch	P	L	L1	L2	L3	I	I1	F1
2L45001	RL45	1/8	6	4	11.3	9.2	14	12	6	63.5	17.2	9.4	21.5	4.3	9.4	3.3
2L45002	RL45	1/4	6	4	11.3	9.2	18	14	8	66.5	17.2	9.4	22.5	4.3	9.4	3.3
2L45007	RL45	1/8	8	6	14	11.3	15	14	6	71.2	19.6	11.5	23	5	11.5	3.3
2L45008	RL45	1/4	8	6	14	11.3	18	14	8	75.6	19.6	11.5	25.4	5	11.5	3.3
2L45009	RL45	3/8	8	6	14	11.3	22	17	9	77.2	19.6	11.5	26	5	11.5	3.3

**PLUG-IN ELBOWS (R46)**

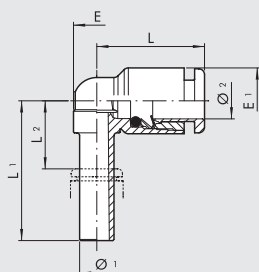

Code	Ref.	Ø1	Ø2	L	L1	L2	E	E1
2L46001	RL46	4	4	16	22.5	8.1	6.8	9.2
2L46002	RL46	6	6	18.5	24	8.4	8	11.3
2L46003	RL46	8	8	21.2	28.5	11.3	10	13.8
2L46004	RL46	10	10	23.3	32	13.3	12.5	16

**EXTENDED PLUG-IN ELBOWS (R47)**

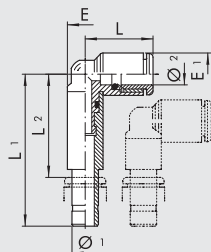

Code	Ref.	Ø1	Ø2	L	L1	L2	E	E1
2L47001	RL47	4	4	15.5	36.9	23.4	7.7	9.2
2L47002	RL47	6	6	18.1	40.6	25.9	9.3	11.3
2L47003	RL47	8	8	19.3	44.9	28.8	9.7	13.8

**DOUBLE ELBOW (R48)**

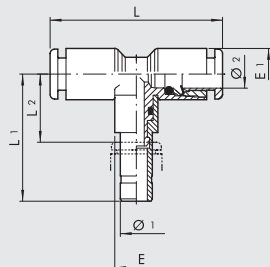

Code	Ref.	Ø1	Ø2	L	L1	L2	E	E1
2L48001	RL48	4	4	32	22.5	8.1	6.8	9.2
2L48002	RL48	6	6	37	37.5	16.4	9.7	11.3
2L48003	RL48	8	8	42.4	28.5	11.3	10	13.8
2L48004	RL48	10	10	46.6	46	27.7	14	16

**DOUBLE LATERAL ELBOW (R49)**

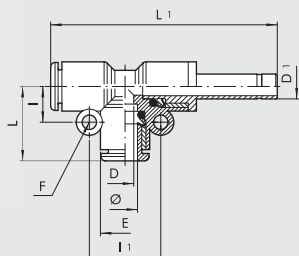

Code	Ref.	Ø	L	L1	I	I1	E	D	D1	F
2L49001	RL49	4	16.7	47.4	7.2	14.4	9.2	2.5	4	3.3
2L49003	RL49	6	19	52.5	8.2	16.4	11.3	4.2	6	3.3
2L49004	RL49	8	21.4	58.4	9.6	19.2	13.8	6.2	8	3.3
2L49005	RL49	10	24.1	68.2	10.9	21.8	16	8.5	10	3.3
2L49006	RL49	12	25.8	74.1	12.5	25	19.5	10.5	12	3.3

## CARTRIDGES AND ACCESSORIES

### BRASS CARTRIDGE WITH THREAD (R26)

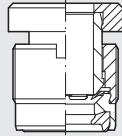

Code	Ref.	Ø	Brace of serration on centers in plastic material [Nm]	Brace of serration on metallic centers [Nm]
<b>SERIES R</b>				
2026A02	R26	3	0.6	0.8
2026A01	R26	3.17	0.6	0.8
2026001	R26	4	0.8	1
2026002	R26	5	0.8	1.5
2026003	R26	6	0.8	1.2
2026004	R26	8	1	1.8
2026005	R26	10	0.8	2
2026006	R26	12	0.8	2

### CARTRIDGE SLOT R26

Ø 3-3.17-4-6-8

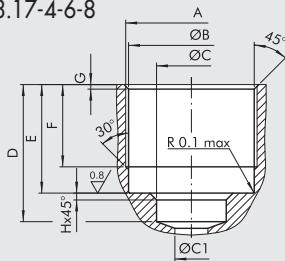

Ø	A	ØB	ØC	ØC1	D	E	F
3-3.17	M7x0.75	6.5 <sup>+0.1</sup> <sub>0</sub>	4.5 <sup>+0.12</sup> <sub>0</sub>	4 max	10.5 <sup>+0.3</sup> <sub>-0</sub>	9.5 <sup>+0.1</sup> <sub>-0.3</sub>	7 <sup>+0.20</sup> <sub>0</sub>
4	M9.5x0.75	9 <sup>+0.10</sup> <sub>0</sub>	4.1 <sup>+0.10</sup> <sub>0</sub>	3 max	12 <sup>+0</sup> <sub>-0.20</sub>	9.5 <sup>+0.15</sup> <sub>-0.05</sub>	7.5 <sup>+0.20</sup> <sub>0</sub>
6	M11.5x0.75	11 <sup>+0.10</sup> <sub>0</sub>	6.1 <sup>+0.10</sup> <sub>0</sub>	5 max	12 <sup>+0.1</sup> <sub>0</sub>	9.5 <sup>+0.1</sup> <sub>0</sub>	7.5 <sup>+0.20</sup> <sub>0</sub>
8	M13.5x0.75	13 <sup>+0.10</sup> <sub>0</sub>	8.1 <sup>+0.10</sup> <sub>0</sub>	7 max	15 <sup>+0</sup> <sub>-0.20</sub>	10.5 <sup>+0.15</sup> <sub>-0.05</sub>	8.5 <sup>+0.20</sup> <sub>0</sub>
Ø	G	H					
3-3.17	0.5	-					
4	0.4	0.6					
6	0.4	0.6					
8	0.4	0.6					

Ø 5-10-12

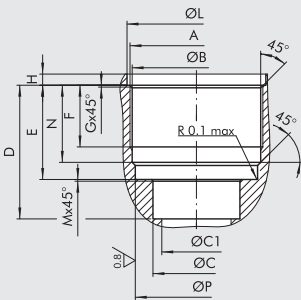

Ø	A	ØB	ØC	ØC1	D	E	F
5	M10.5x0.75	10 <sup>+0.1</sup> <sub>0</sub>	5 <sup>+0.15</sup> <sub>0</sub>	4 max	11.8 <sup>+0.1</sup> <sub>0</sub>	8.9 <sup>+0.1</sup> <sub>0</sub>	5.8 <sup>+0.3</sup> <sub>0</sub>
10	M15.5x0.75	15 <sup>+0.1</sup> <sub>0</sub>	10 <sup>+0.15</sup> <sub>0</sub>	9 max	15.6 <sup>+0.1</sup> <sub>0</sub>	11 <sup>+0.05</sup> <sub>0</sub>	7.5 <sup>+0.3</sup> <sub>0</sub>
12	M18x1	17.5 <sup>+0.05</sup> <sub>0.1</sub>	12 <sup>+0.05</sup> <sub>+0.15</sub>	11 max	18 <sup>+0.1</sup> <sub>0</sub>	12 <sup>+0.05</sup> <sub>0</sub>	6.8 <sup>+0.3</sup> <sub>0</sub>
Ø	G	H	ØL	M	N	ØP	
5	0.3	0.9 <sup>+0</sup> <sub>-0.3</sub>	11.2 <sup>+0.12</sup> <sub>+0.02</sub>	0.1	7.8 <sup>+0.05</sup> <sub>0</sub>	9.7 <sup>+0.05</sup> <sub>0</sub>	
10	0.3	1.3 <sup>+0</sup> <sub>-0.3</sub>	16.2 <sup>+0.1</sup> <sub>-0.05</sub>	0.2	9 <sup>+0.05</sup> <sub>0</sub>	14.9 <sup>+0.10</sup> <sub>-0</sub>	
12	0.6	1.3 <sup>+0</sup> <sub>-0.3</sub>	18.8 <sup>+0.1</sup> <sub>0</sub>	0.2	9.75 <sup>+0.1</sup> <sub>-0.15</sub>	17 <sup>+0.1</sup> <sub>-0</sub>	

### TOOL FOR SLOT R26

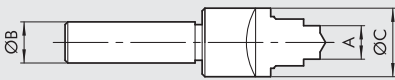

Code	Ref.	A	ØB	ØC
2025010	UT.SE. R26 3-3.17	4.5	10	10
2025011	UT.SE. R26 4	4.1	12	18
2025012	UT.SE. R26 5	5.1	15	20
2025013	UT.SE. R26 6	6.1	16	19
2025014	UT.SE. R26 8	8.1	16	21
2025015	UT.SE. R26 10	10.1	16	25
2025016	UT.SE. R26 12	12.1	15	28

### MALE FOR CARTRIDGE SLOT R26

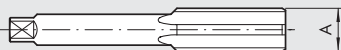

Code	Ref.	Ø	A
2025020	MA R26 3-3.17	3-3.17	M7x0.75
2025021	MA R26 4	4	M9.5x0.75
2025022	MA R26 5	5	M10.5x0.75
2025023	MA R26 6	6	M11.5x0.75
2025024	MA R26 8	8	M13.5x0.75
2025025	MA R26 10	10	M15.5x0.75
2025026	MA R26 12	12	M18x1

**BRASS COMPRESSION CARTRIDGE (R27)**

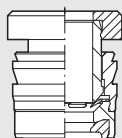

Code Ref. Ø

**SERIES R**

2027001	R27	4
2027002	R27	5
2027003	R27	6
2027004	R27	8
2027005	R27	10
2027006	R27	12

**CARTRIDGE SLOT R27**

Ø 4-6-8

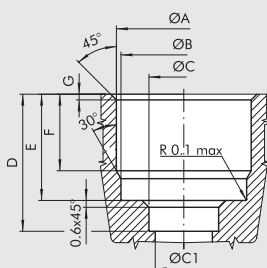

Ø	Ø A	Ø B	Ø C	Ø C1	D	E	F	G
<b>FOR ALUMINIUM</b>								
4	9.2 <sup>+0.10</sup> <sub>-0.10</sub>	9 <sup>+0.10</sup> <sub>-0</sub>	4.1 <sup>+0.10</sup> <sub>-0</sub>	3 MAX	12 <sup>+0</sup> <sub>-0.20</sub>	9.3 <sup>+0</sup> <sub>-0.10</sub>	6.7 <sup>+0.10</sup> <sub>-0</sub>	0.5
6	11.3 <sup>+0</sup> <sub>-0.08</sub>	11 <sup>+0.10</sup> <sub>-0</sub>	6.1 <sup>+0.10</sup> <sub>-0</sub>	5 MAX	12 <sup>+0</sup> <sub>-0.20</sub>	9.3 <sup>+0</sup> <sub>-0.10</sub>	6.7 <sup>+0.10</sup> <sub>-0</sub>	0.5
8	13.3 <sup>+0</sup> <sub>-0.08</sub>	13 <sup>+0.10</sup> <sub>-0</sub>	8.1 <sup>+0.10</sup> <sub>-0</sub>	7 MAX	15 <sup>+0</sup> <sub>-0.20</sub>	10.3 <sup>+0</sup> <sub>-0.10</sub>	7.7 <sup>+0.10</sup> <sub>-0</sub>	0.5

**FOR TECHNOPOLYMER**

4	*9.2 <sup>+0</sup> <sub>-0.10</sub>	9 <sup>+0.10</sup> <sub>-0</sub>	4.1 <sup>+0.10</sup> <sub>-0</sub>	3 MAX	12 <sup>+0</sup> <sub>-0.20</sub>	9.3 <sup>+0</sup> <sub>-0.10</sub>	6.7 <sup>+0.10</sup> <sub>-0</sub>	0.5
6	*11.2 <sup>+0</sup> <sub>-0.10</sub>	11 <sup>+0.10</sup> <sub>-0</sub>	6.1 <sup>+0.10</sup> <sub>-0</sub>	5 MAX	12 <sup>+0</sup> <sub>-0.20</sub>	9.3 <sup>+0</sup> <sub>-0.10</sub>	6.7 <sup>+0.10</sup> <sub>-0</sub>	0.5
8	*13.2 <sup>+0</sup> <sub>-0.10</sub>	13 <sup>+0.10</sup> <sub>-0</sub>	8.1 <sup>+0.10</sup> <sub>-0</sub>	7 MAX	15 <sup>+0</sup> <sub>-0.20</sub>	10.3 <sup>+0</sup> <sub>-0.10</sub>	7.7 <sup>+0.10</sup> <sub>-0</sub>	0.5

\* N.B.: the diameter in interference is purely an indication and depends on the type of plastic material used and on its thickness. We suggest you should effect practical assembling tests.

Ø 5-10-12

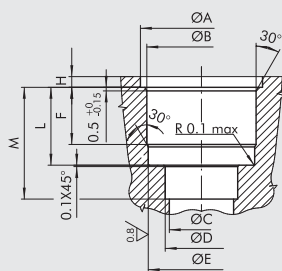

Ø	Ø A	Ø B	Ø C	Ø D	Ø E	F	H	L	M
<b>FOR TECHNOPOLYMER</b>									
5	12.1 <sup>+0.15</sup> <sub>-0</sub>	*10.2 <sup>+0</sup> <sub>-0.10</sub>	4 MAX	5.1 <sup>+0.15</sup> <sub>-0</sub>	9.7 ±0.05	6 <sup>+0.2</sup> <sub>-0</sub>	1.2 <sup>-0</sup> <sub>-0.2</sub>	8.75 <sup>-0</sup> <sub>-0.1</sub>	11.8 ±0.10
10	17.1 <sup>+0.15</sup> <sub>-0</sub>	*15.15 <sup>+0</sup> <sub>-0.08</sub>	9 MAX	10.15 <sup>+0.1</sup> <sub>-0</sub>	14.9 ±0.05	8 <sup>+0.2</sup> <sub>-0</sub>	1.5 <sup>-0.2</sup> <sub>-0.2</sub>	10.9 <sup>-0</sup> <sub>-0.1</sub>	15.6 ±0.10
12	19.7 <sup>+0.15</sup> <sub>-0</sub>	*17.55 <sup>+0</sup> <sub>-0.08</sub>	11 MAX	12.15 <sup>+0.1</sup> <sub>-0</sub>	17.1 ±0.05	9 <sup>+0.2</sup> <sub>-0</sub>	1.5 <sup>-0.2</sup> <sub>-0.2</sub>	11.85 <sup>-0</sup> <sub>-0.1</sub>	18 ±0.10

**FOR ALUMINIUM**

5	12.1 <sup>+0.15</sup> <sub>-0</sub>	10.3 <sup>+0</sup> <sub>-0.08</sub>	4 MAX	5.1 <sup>+0.15</sup> <sub>-0</sub>	9.7 ±0.05	6 <sup>+0.2</sup> <sub>-0</sub>	1.2 <sup>-0</sup> <sub>-0.2</sub>	8.75 <sup>-0</sup> <sub>-0.1</sub>	11.8 ±0.10
10	17.1 <sup>+0.15</sup> <sub>-0</sub>	15.4 <sup>+0</sup> <sub>-0.08</sub>	9 MAX	10.15 <sup>+0.1</sup> <sub>-0</sub>	14.9 ±0.05	8 <sup>+0.2</sup> <sub>-0</sub>	1.5 <sup>-0.2</sup> <sub>-0.2</sub>	10.9 <sup>-0</sup> <sub>-0.1</sub>	15.6 ±0.10
12	19.7 <sup>+0.15</sup> <sub>-0</sub>	17.8 <sup>+0</sup> <sub>-0.08</sub>	11 MAX	12.15 <sup>+0.1</sup> <sub>-0</sub>	17.1 ±0.05	9 <sup>+0.2</sup> <sub>-0</sub>	1.5 <sup>-0.2</sup> <sub>-0.2</sub>	11.85 <sup>-0</sup> <sub>-0.1</sub>	18 ±0.10

\* N.B.: the diameter in interference is purely an indication and depends on the type of plastic material used and on its thickness. We suggest you should effect practical assembling tests.

**TOOL FOR SLOT R27**

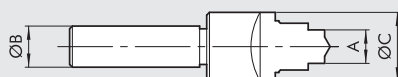

Code Ref. A Ø B Ø C

**FOR ALUMINIUM**

2027021	UT.SE. R27 AL. 4	4.1	10	11.5
2027022	UT.SE. R27 AL. 5	5.1	12	16
2027023	UT.SE. R27 AL. 6	6.1	12	13.5
2027024	UT.SE. R27 AL. 8	8.1	12	15.5
2027025	UT.SE. R27 AL. 10	10.1	16	20
2027026	UT.SE. R27 AL. 12	12.1	16	22

**FOR TECHNOPOLYMER**

2027011	UT.SE. R27 P. 4	4.1	10	11.5
2027012	UT.SE. R27 P. 5	5.1	12	16
2027013	UT.SE. R27 P. 6	6.1	12	13.5
2027014	UT.SE. R27 P. 8	8.1	12	15.5
2027015	UT.SE. R27 P. 10	10.1	16	20
2027016	UT.SE. R27 P. 12	12.1	16	22

**R17 – DISASSEMBLY KEY**

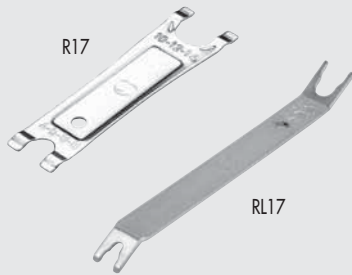

Code	Ref.	Lenght (mm)	Ø Tube
2L17001	RL17	140	from 3 to 10
2017001	R17	95.0	from 4 to 14

**R41 – CARTRIDGE KEY R26**

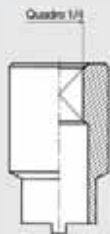

Code	Ref.	Ø
2041001	R41	4
2041002	R41	5
2041003	R41	6
2041004	R41	8
2041005	R41	10
2041006	R41	12

**NOTES**